

Key Characteristics

High and stable operating voltage

Low self-discharge rate (less than 3% after 1 year storage at 25°C)

Operating temperature (-40°C ~ +60°C)

Hermetic glass-to-metal sealing

Nickel-plated steel container

Organic electrolyte

Spiral type

UL (MH48131), CE

http://database.ul.com/cgi-bin/XYV/template/LISEXT/1FRAME/showpage.html?name=BBCV2.MH48131&ccnshorttitle=Lithium+Batteries+-+Component&objid=1081630466&cfgid=1073741824&version=versionless&parent_id=1073747351&sequence=1

ISO9001:2008 approved

Warning

Fire, explosion and severe burn hazard.

Do not recharge, crush, disassemble, heat, above 212 F (100°C), incinerate, short circuit or expose contents to water.

Do not reverse the positive and negative pole of battery while using it.

Do not solder directly on the battery.

Dispose of used batteries promptly.

Please see latest guidelines, cautions and MSDS online:

<http://en.globtek.com/safety-cautions/>

Characteristics

Chemistry: Lithium Thionyl Chloride Li₂SOCl₂ Batteries

Nominal capacity (10mA-2.0v) 2000mAh

Nominal voltage 3.0v

Max. constant current 2000mA

Max. pulse current 3000mA

Weight 26g

Volume 17.0 X 45.0mm

Workable temperature -540 ~ +0°C



Main Applications

Utility meters (electricity meters, water meters, gas meters.

Security systems (door lockers, smoke alarm sensors, detectors)

CMOS memory and RTC backup

Vehicle tracking

Industrial clocks

Sea buoys, remote monitoring systems, industrial clocks

Military electronics

Note: Any information here is for reference only. Information is also dependent on actual conditions of use does not guarantee future performance. And subject to change.

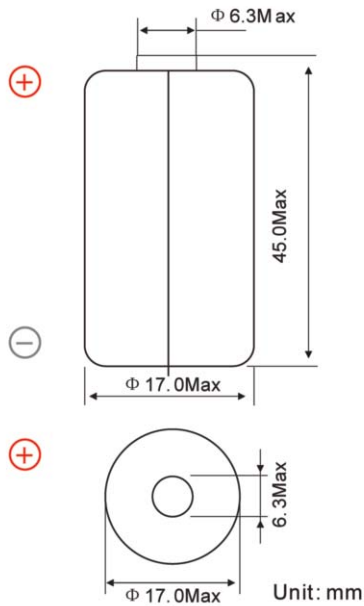

Available terminations:

- /P axial pins
- T/PT2 radial pins
- /PT/TP polarized tabs

Available terminations can be made as requested.

Voltage vs Temperature

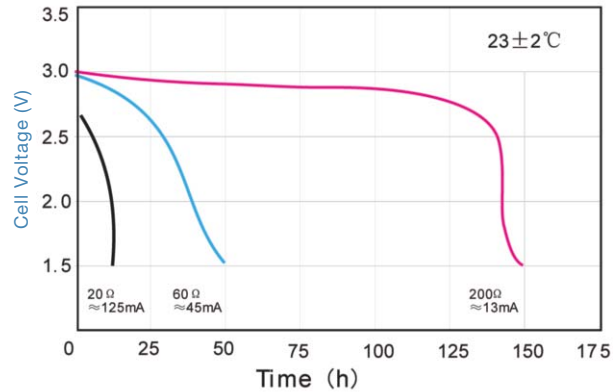

Discharge Characteristics

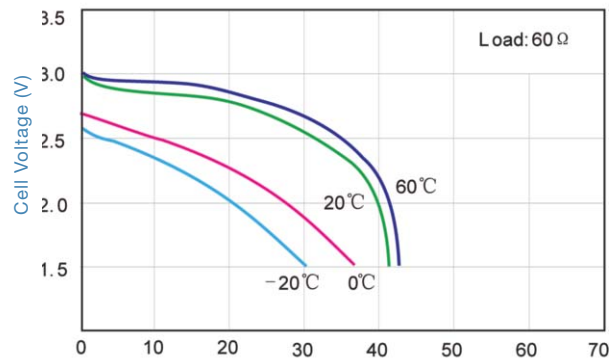

Storage Characteristics

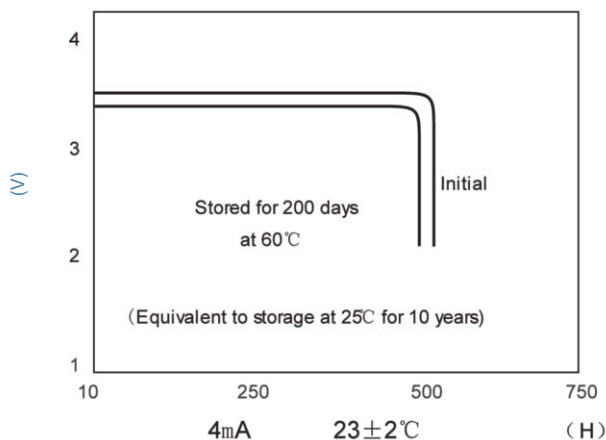

Capacity vs Current

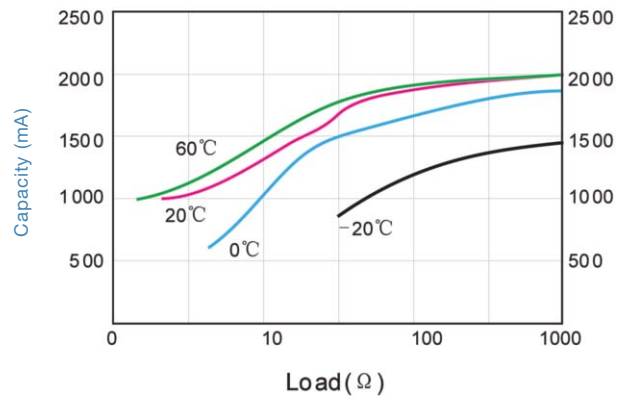

Note: Any information here is for reference only. Information is also dependent on actual conditions of use does not guarantee future performance. And subject to change.